

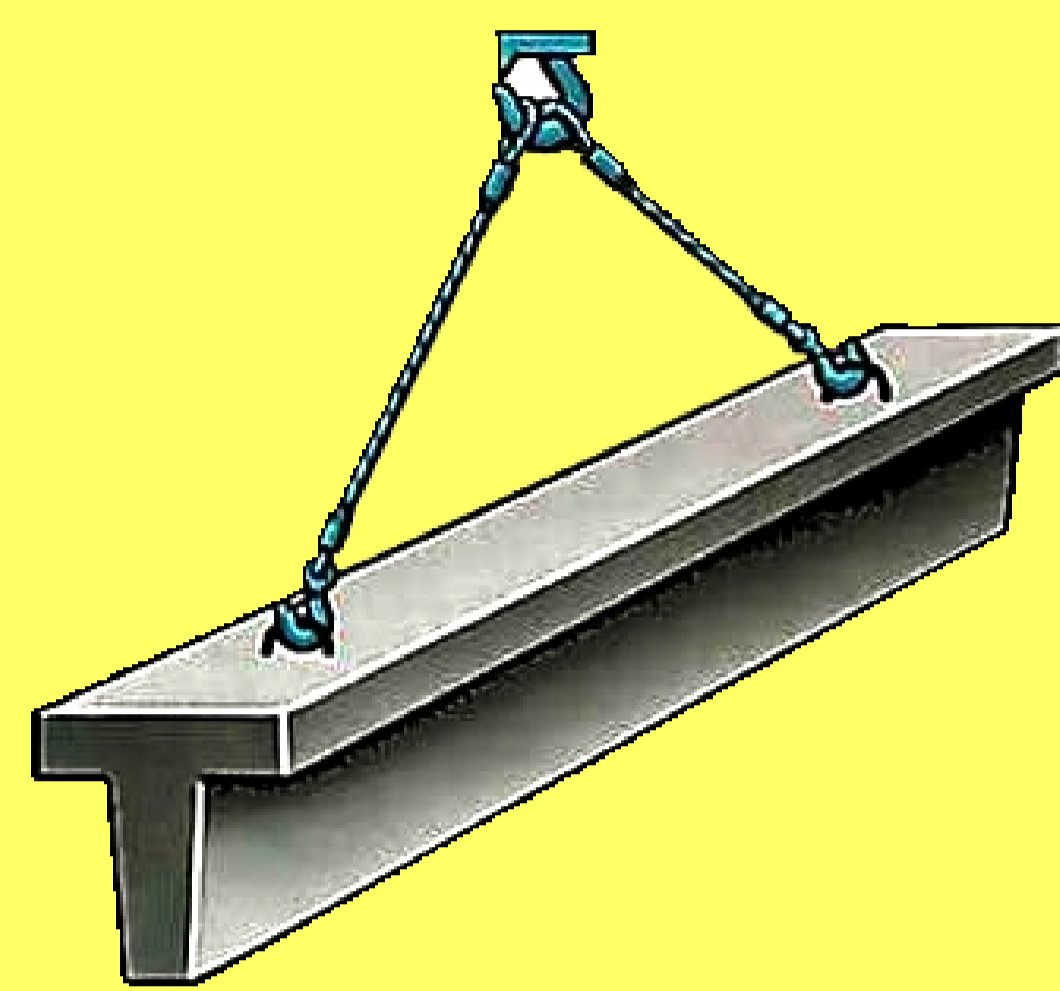

YUK KO'TARISH KRANLARI BILAN ISHLASHDA YUKLARNI ILISH VA TAXLASH SXEMASI

TEMIRBETONLI BALKA



DEVOR PANELI

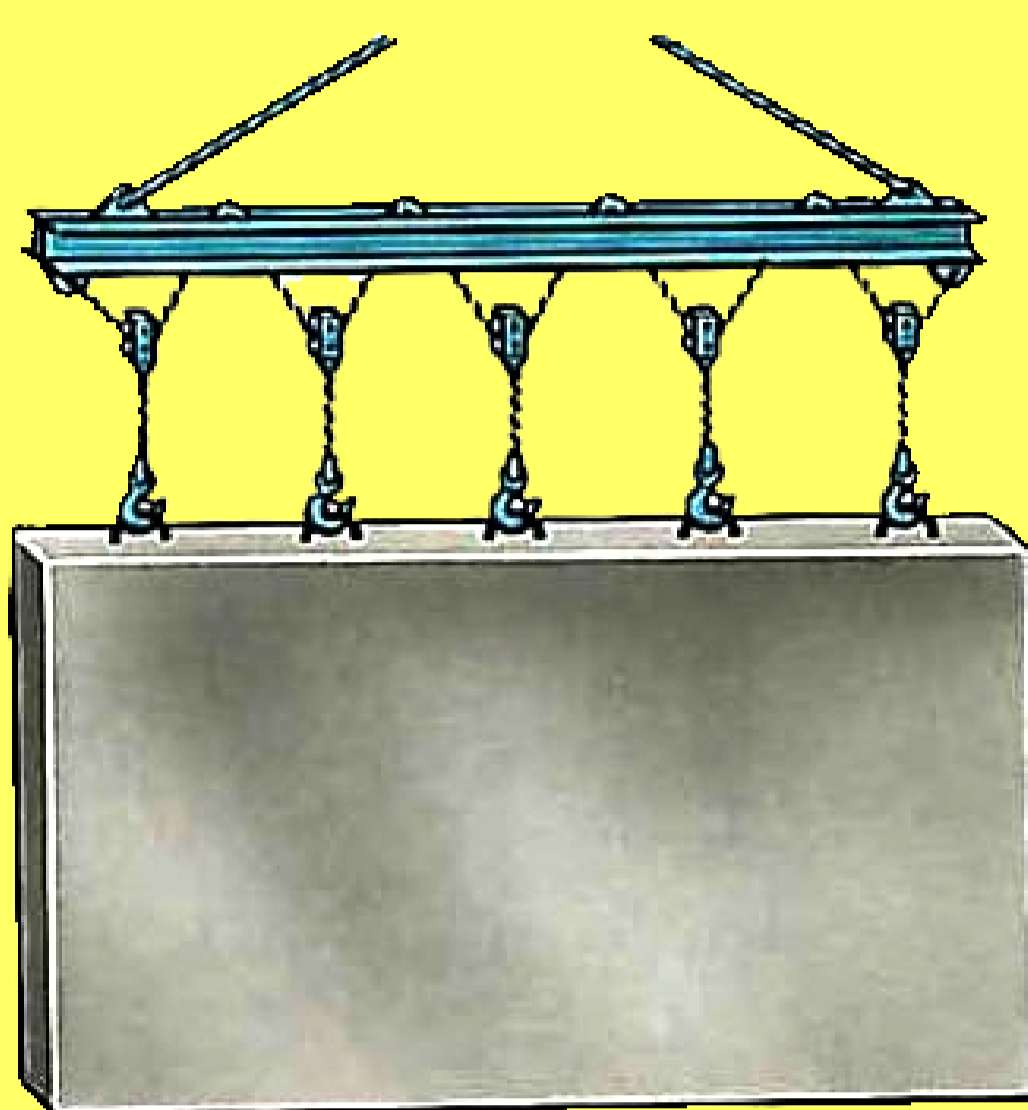

TO'SHAMA PLITASI

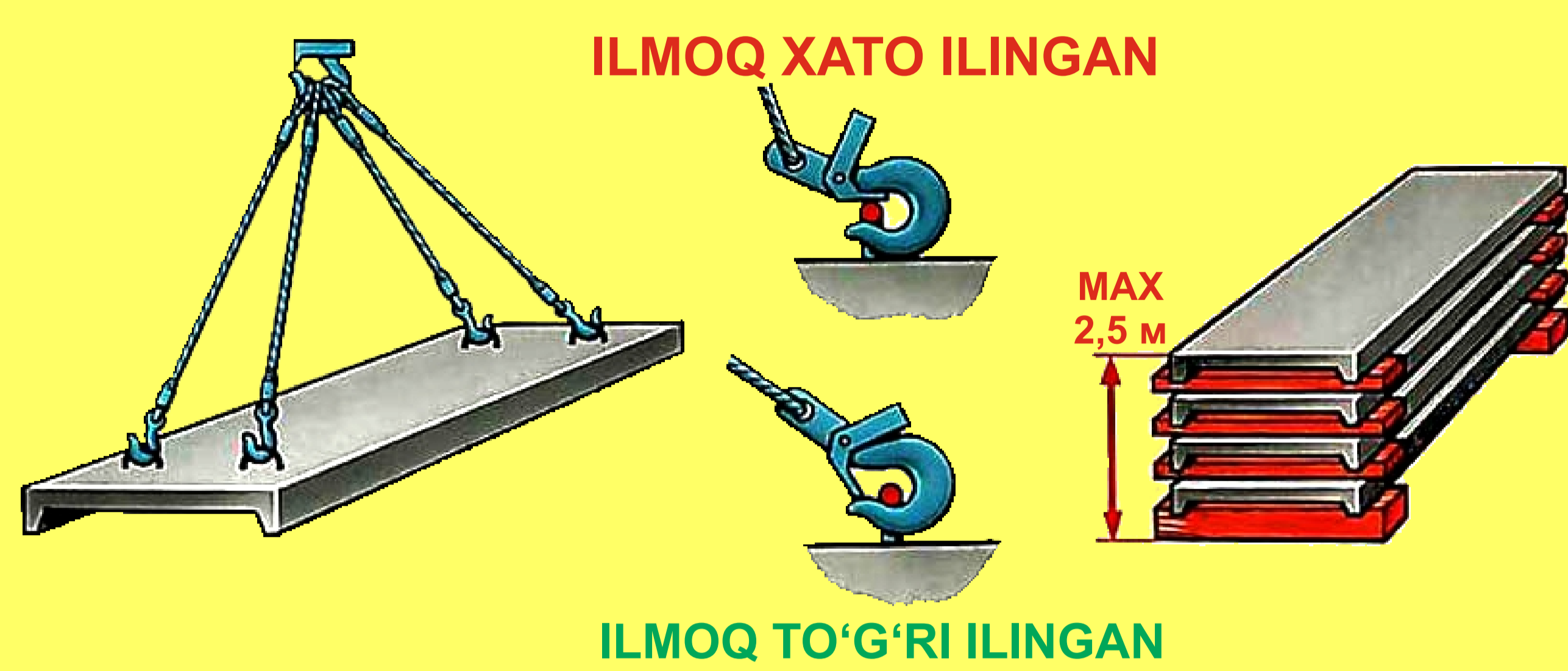

TEMIRBETON BALKANI KO'TARISHDA TAGLIKLARDAN FOYDALANISH

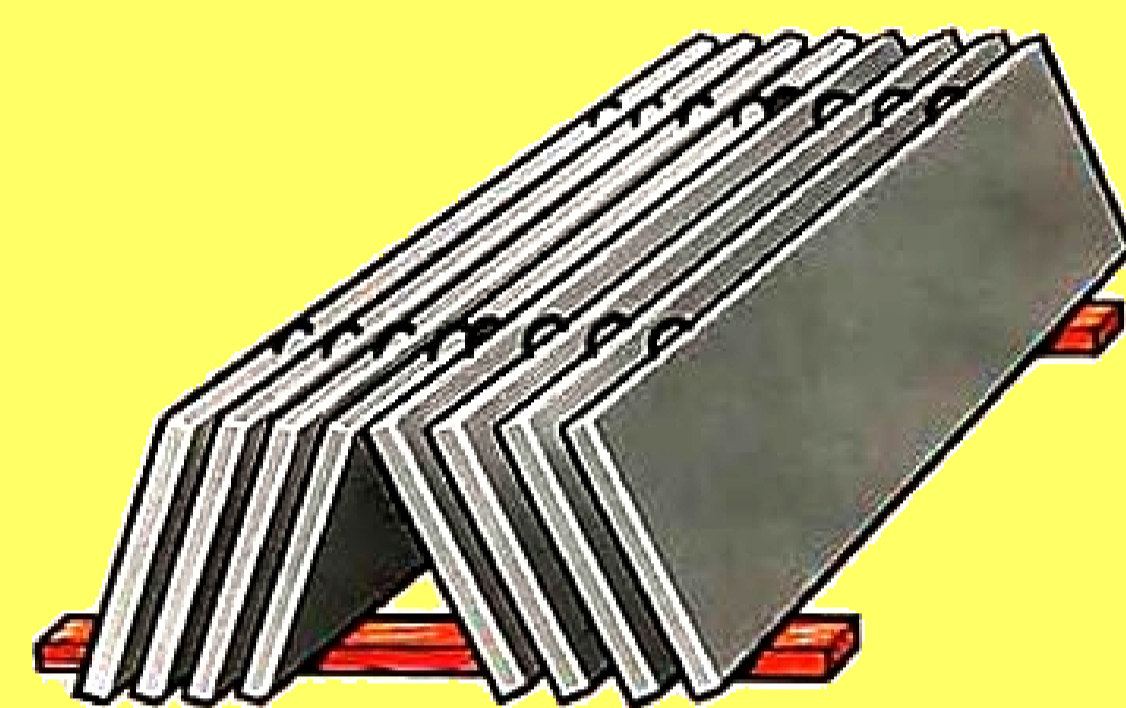
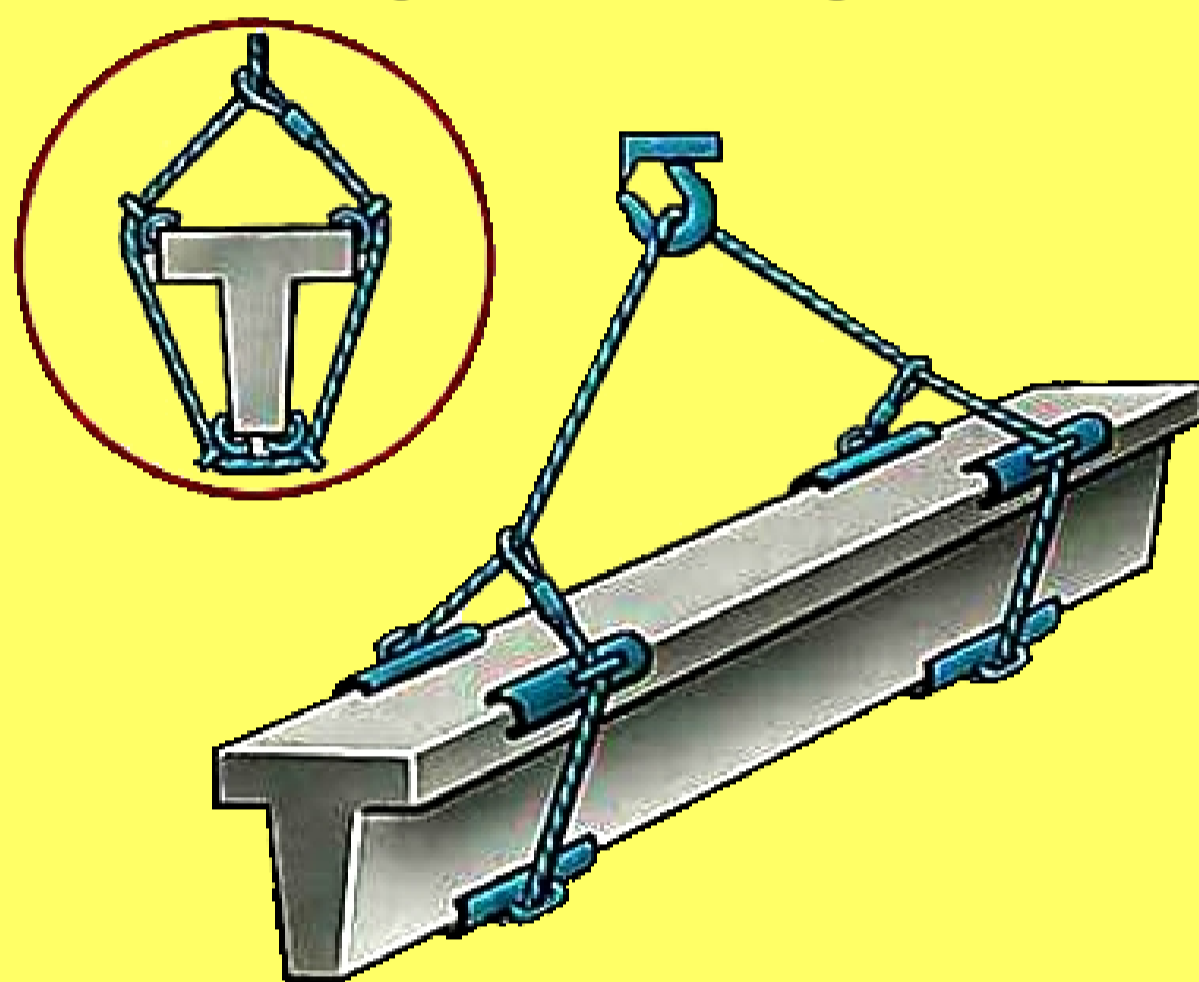

QO'SHTAVR BALKALARNI KO'TARISH

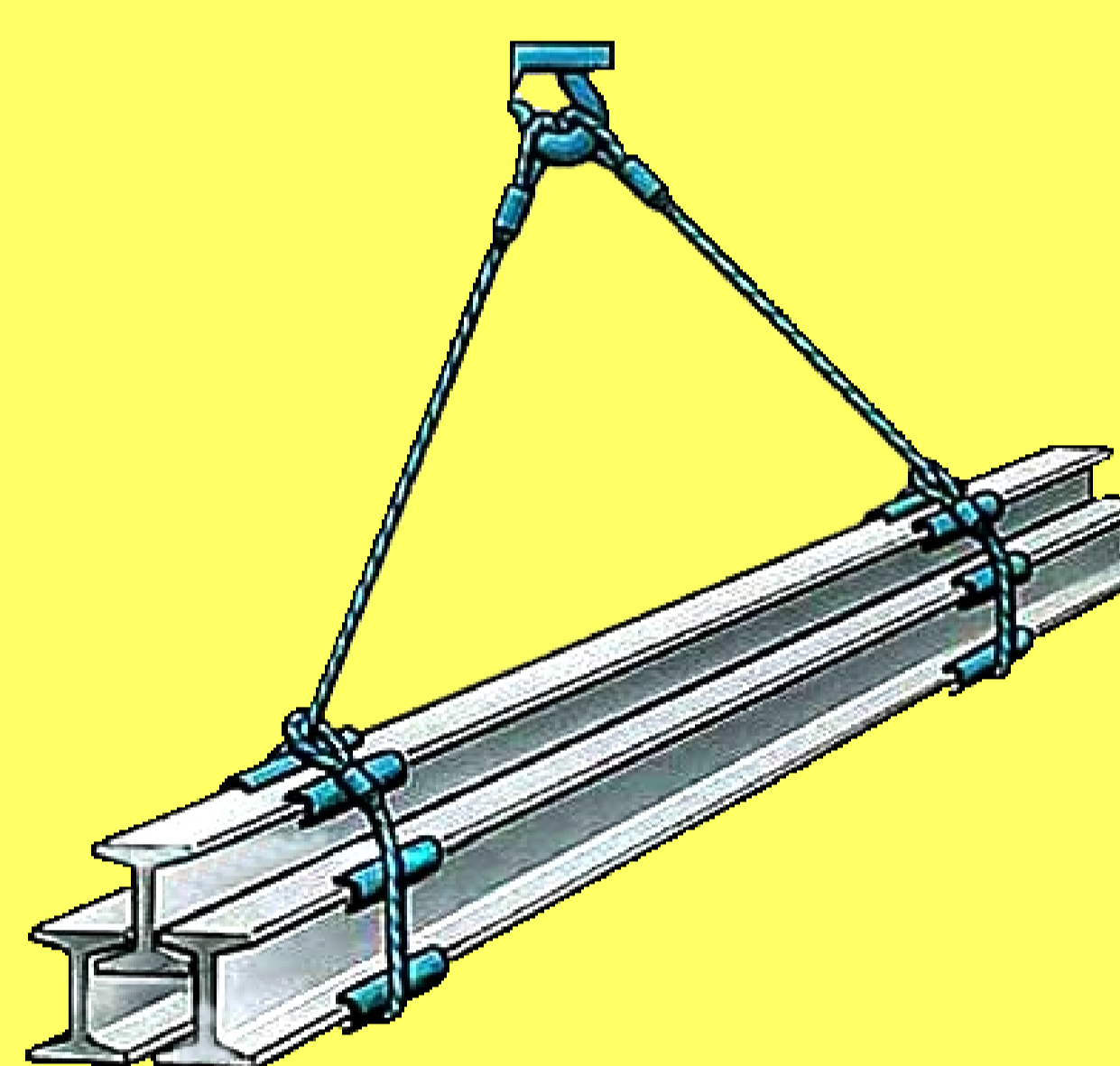

PO'LAT QUVURLARNI KO'TARISH

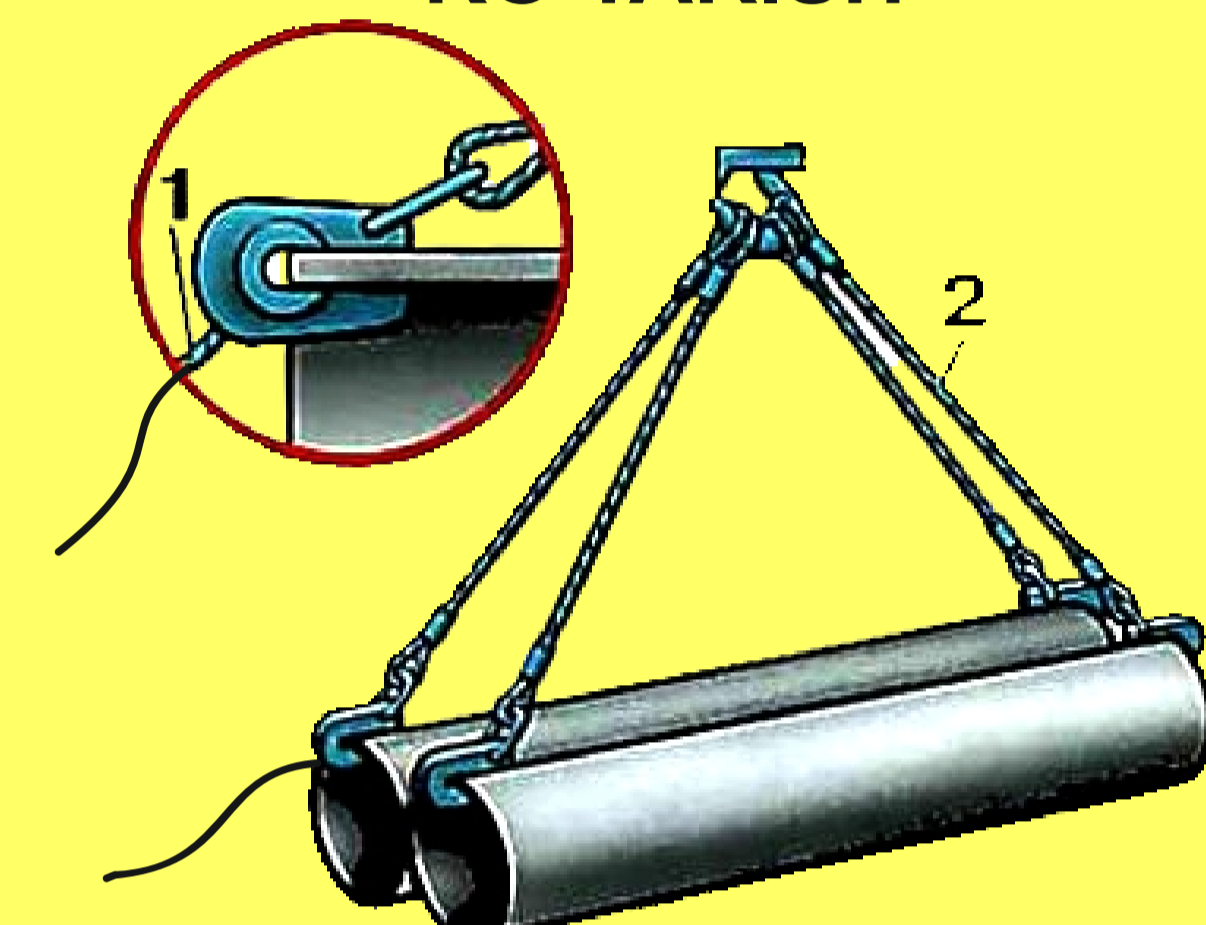

YOG'OCH MATERIALLARNI JAMLAB KO'TARISH

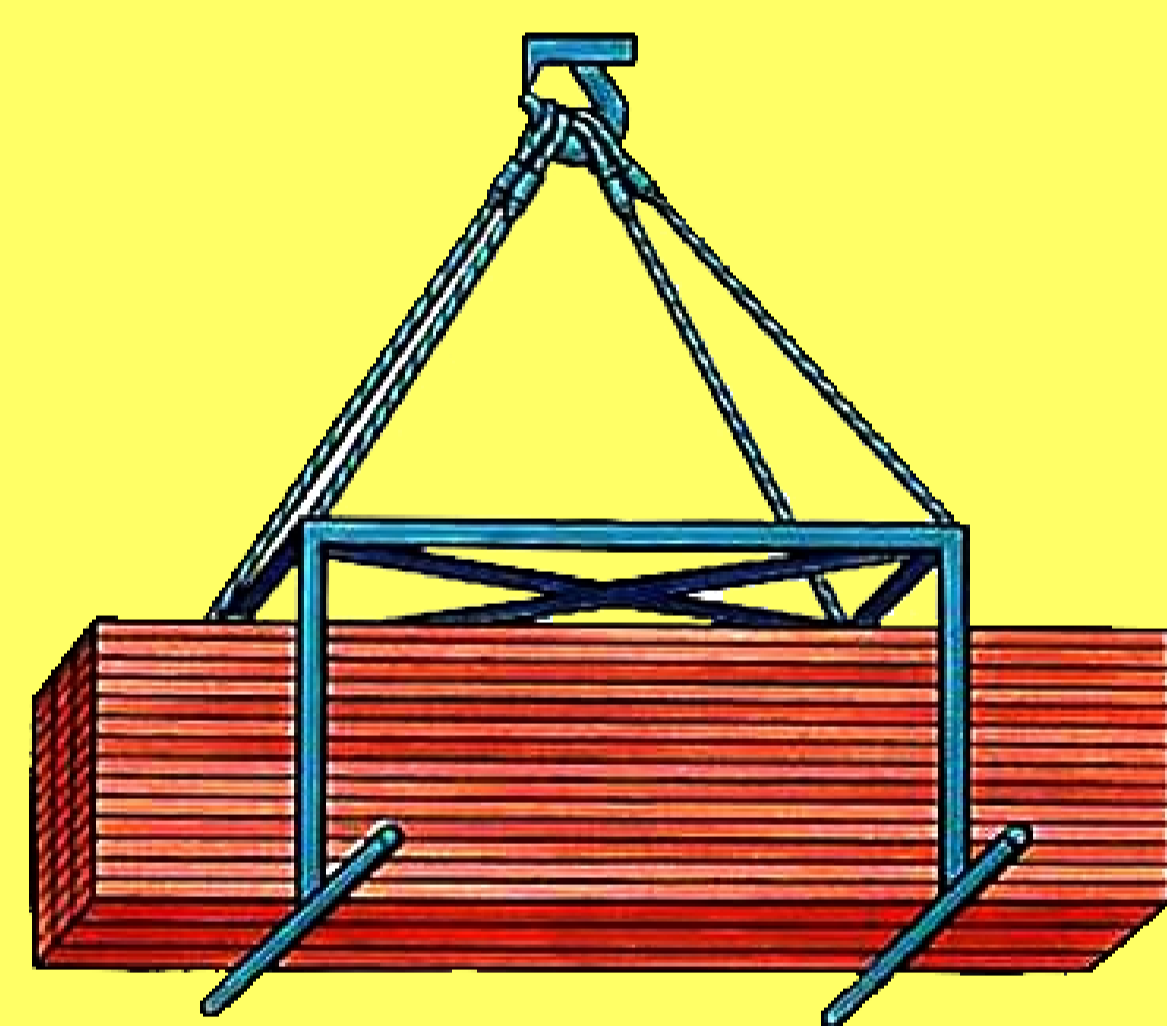

YOG'OCHLARNI SHTABEL USULIDA TAXLASH

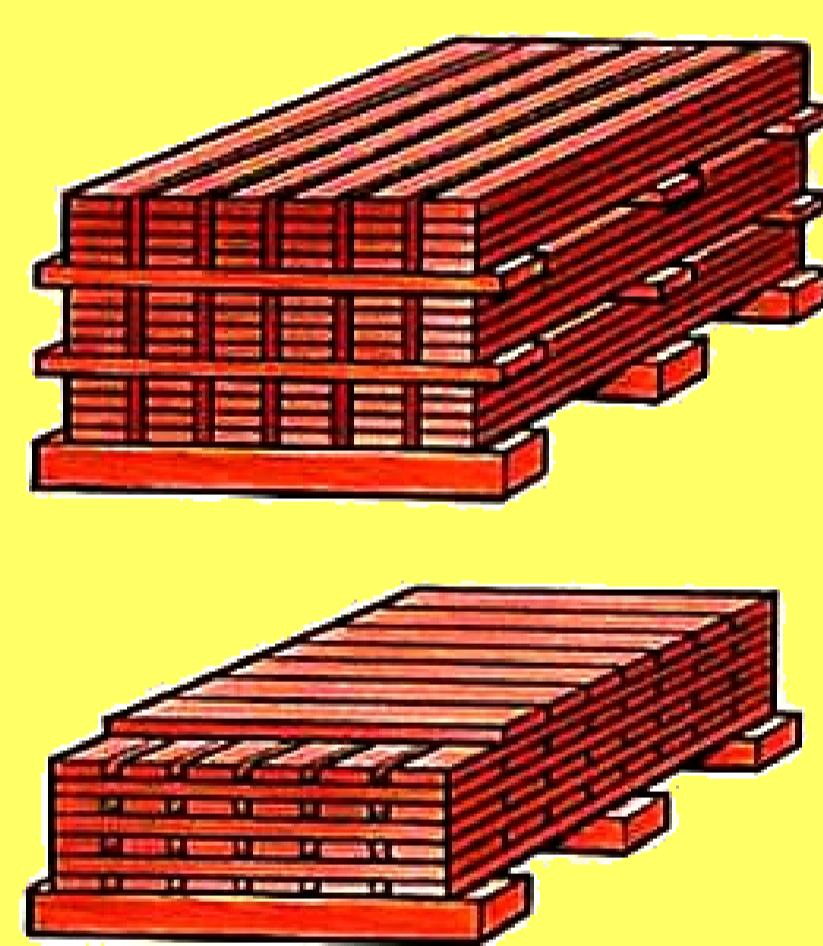

QO'SHTAVR BALKALARNING TAXLANISHI

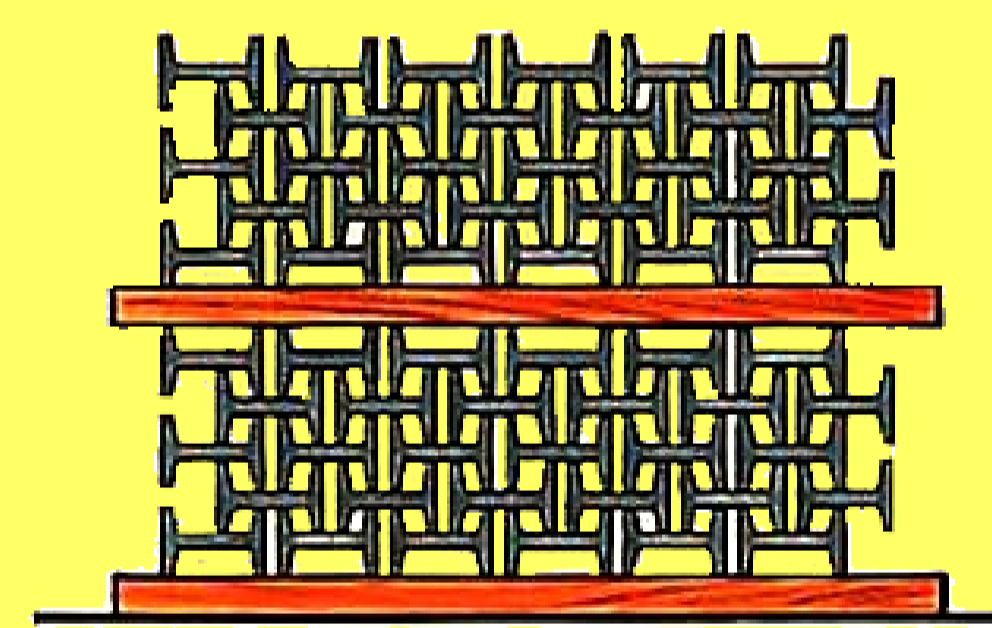

PO'LAT QUVURLARNI KO'TARISH

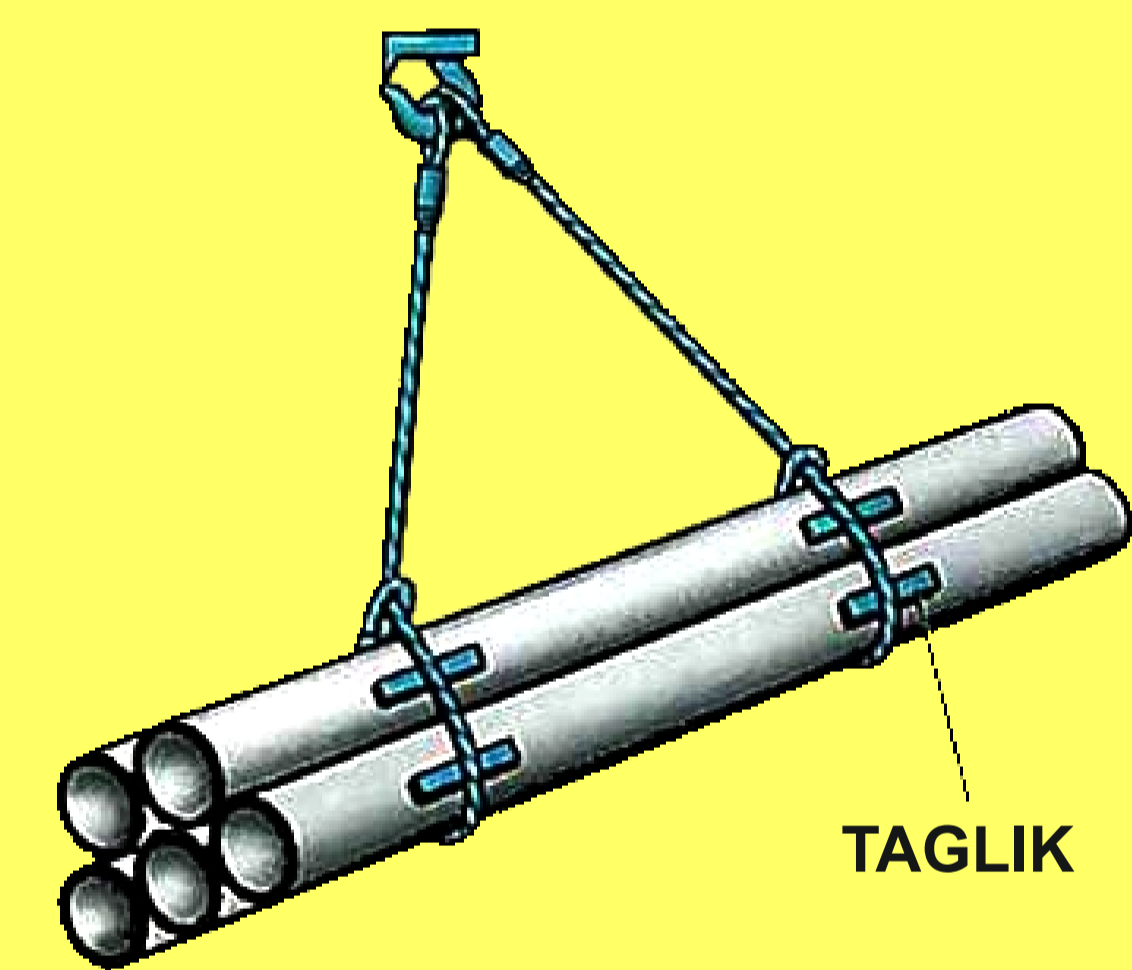

YOG'OCH TO'SINLARNI KO'TARISH

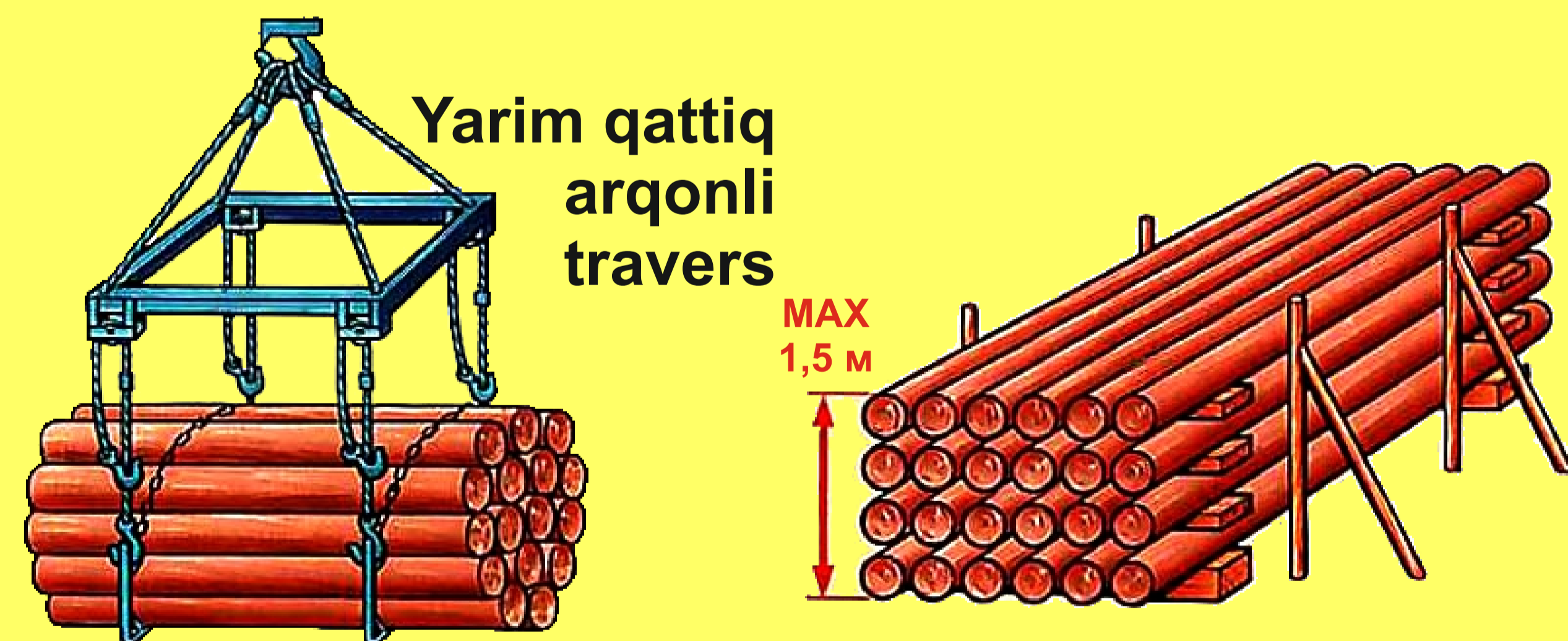

PO'LAT LISTLAR

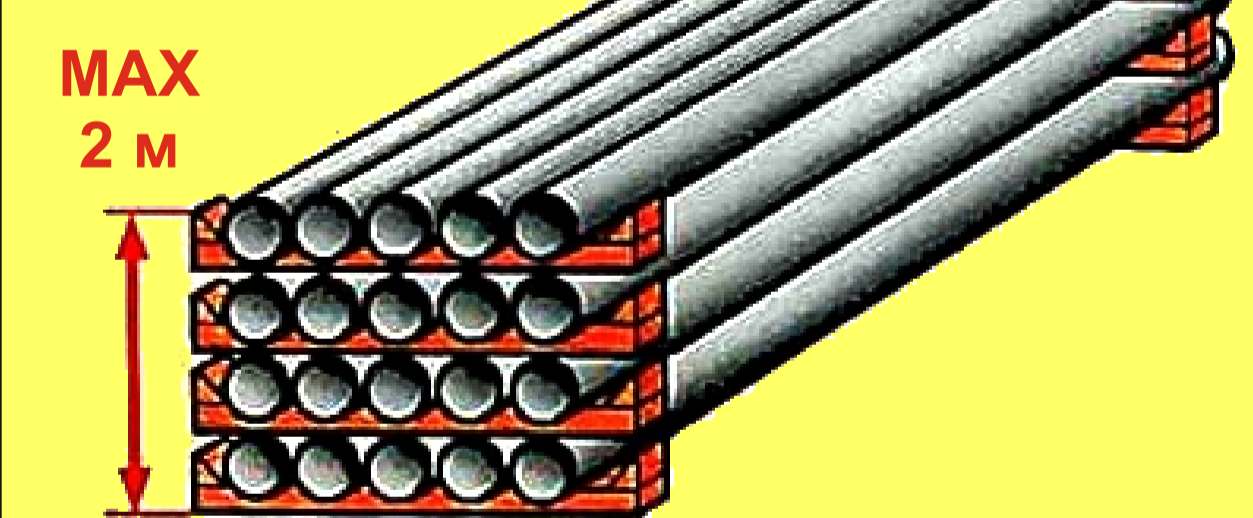
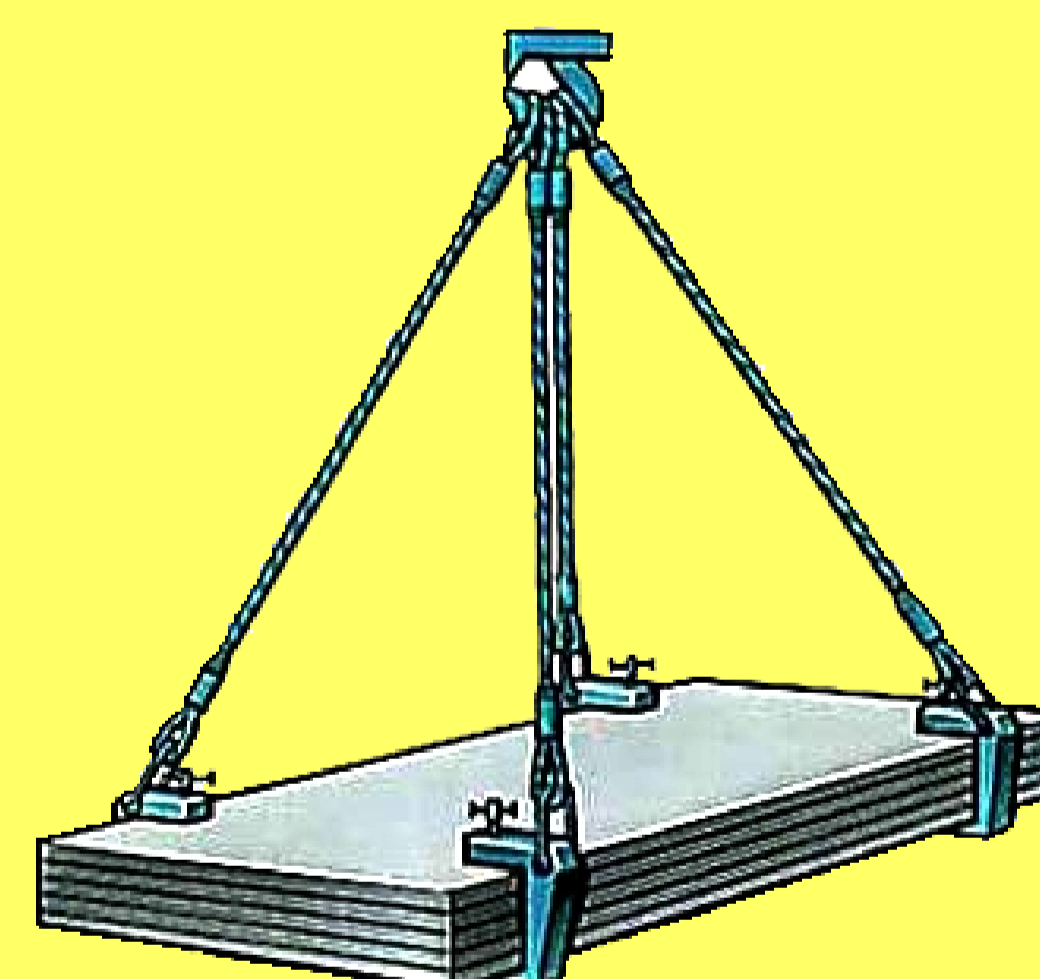

SIM ARQON YEDIRILISHIGA QARSHI TAGLIKLAR

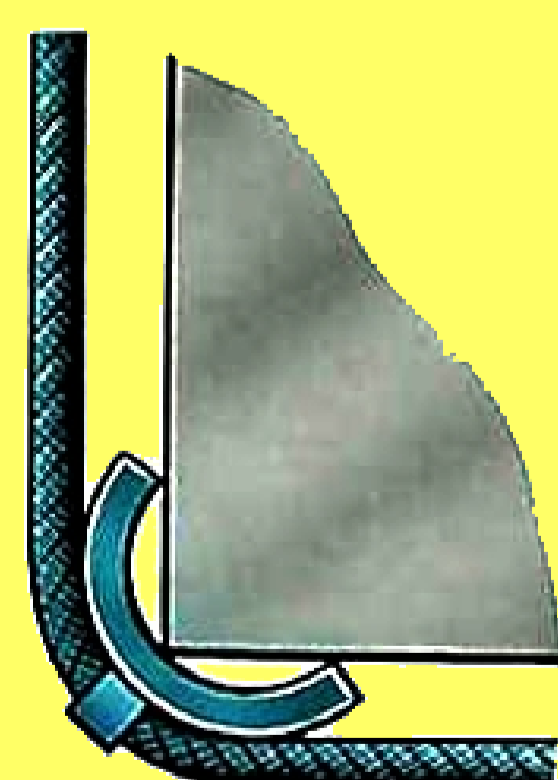

Xalqa payvandlangan kesilgan po'lat quvurli taglik

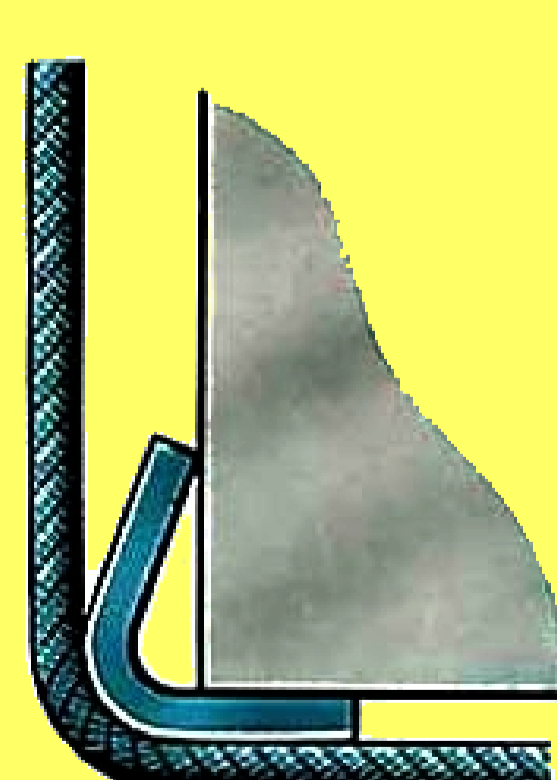

Bukilgan po'lat listli taglik

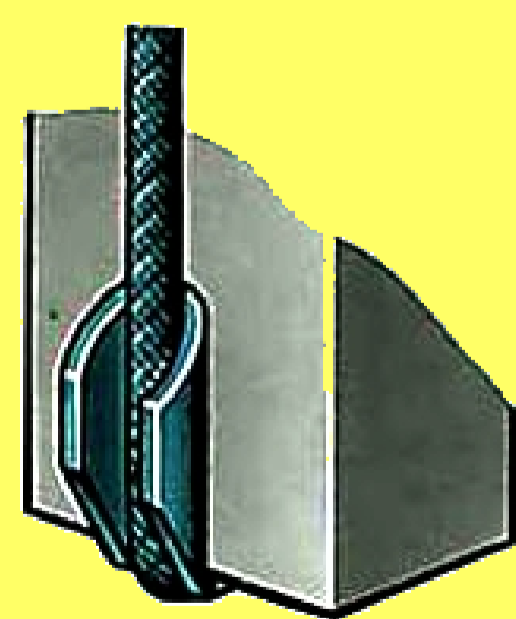

Kesib bukilgan po'lat quvurli taglik

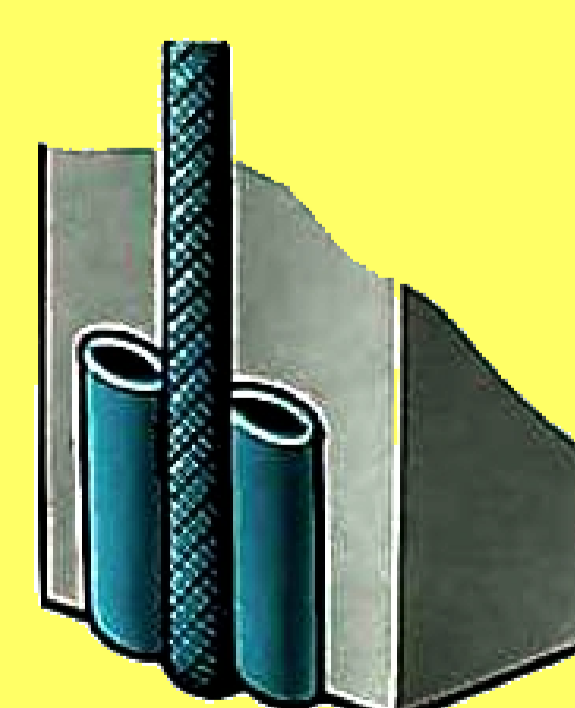

Bukilgan po'lat quvurli taglik

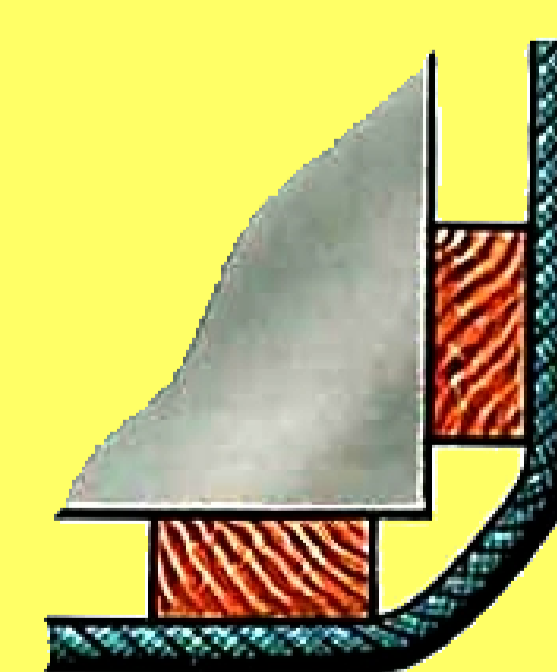

Yog'och tagliklar

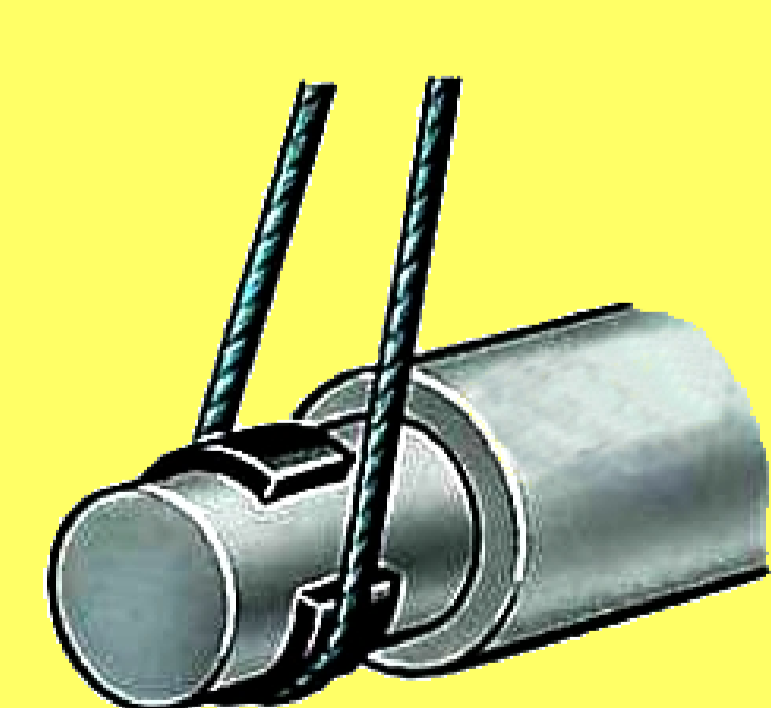

Ipli rezina shlang yoki rezina kamerali taglik

**XAVFSIZLIK QOIDALARIGA AMAL QILMASLIK,
OG'IR OQIBATLARGA OLIB KELISHI MUMKIN**

YUKLAB OLING

